

User's Guide

TO-Can Laser Diode Mount LDM-4405



 **ILX Lightwave**
Laser Diode Instrumentation & Test Systems

ILX Lightwave Corporation · P. O. Box 6310 · Bozeman, MT, U.S.A. 59771 · U.S. & Canada: 1-800-459-9459 · International Inquiries: 406-556-2481 · Fax 406-586-9405

ilx.custhelp.com · www.ilxlightwave.com

TABLE OF CONTENTS

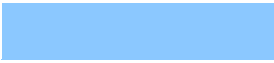

Table of Contents	i
List of Figures and Tables	iii
Safety and Warranty Information	v
Safety Information and the Manual	v
General Safety Considerations	v
Safety Symbols	vi
Safety Marking Symbols	vi
Warranty	vii
Comments, Suggestions, and Problems	viii
Chapter 1 Introduction	
Product Overview	1
Specifications	3
Chapter 2 Operation	
Mount Configuration	5
Laser Diode Mounting	7
Current Sources and Current Measurements	10
Temperature Control and Condensation	12
Thermoelectric Temperature Control	12
Nitrogen Purge	12

Chapter 3 Safety

LIST OF FIGURES AND TABLES

Figure 1.1	Exploded View of the LDM-4405	2
Figure 1.2	Rear View of the LDM-4405	2
Figure 1.3	Socket Connection Type I	3
Figure 2.1	Pin Arrangement of the LDM-4405	5
Figure 2.2	Laser Diode Insertion	8
Figure 2.3	Mount with Laser and Cover/Clamp Installed	9
Figure 2.4	LDM-4405 Laser Cable Pinouts	10
Figure 2.5	LDM-4405 TE Module Cable Pinouts	11
Table 2.1	Pinout Combinations and Configurations of Laser Diodes - LDM-4405	6



LIST OF FIGURES AND TABLES

SAFETY AND WARRANTY INFORMATION

The Safety and Warranty Information section provides details about cautionary symbols used in the manual, safety markings used on the instrument, and information about the Warranty including Customer Service contact information.

Safety Information and the Manual

Throughout this manual, you will see the words *Caution* and *Warning* indicating potentially dangerous or hazardous situations which, if not avoided, could result in death, serious or minor injury, or damage to the product. Specifically:

CAUTION

Caution indicates a potentially hazardous situation which can result in minor or moderate injury or damage to the product or equipment.

WARNING

Warning indicates a potentially dangerous situation which can result in serious injury or death.

WARNING

Visible and/or invisible laser radiation. Avoid direct exposure to the beam.

General Safety Considerations

If any of the following conditions exist, or are even suspected, do not use the system until safe operation can be verified by trained service personnel:

- Visible damage
- Severe transport stress
- Prolonged storage under adverse conditions
- Failure to perform intended measurements or functions

If necessary, contact ILX Lightwave or the authorized local ILX Lightwave distributor, for information on how the appropriate system components should be removed and sent back to ILX for servicing. (see the contact information on page viii).

All components returned to ILX Lightwave are required to have a Return Authorization Number assigned by an official representative of ILX Lightwave Corporation. See Claims for Shipping Damage on page vii for more information.

SAFETY SYMBOLS











This section describes the safety symbols and classifications.

Technical specifications including electrical ratings and weight are included within the manual. See the Table of Contents to locate the specifications and other product information. The following classifications are standard across all ILX Lightwave products:

- Indoor use only
- Ordinary Protection: This product is NOT protected against the harmful ingress of moisture.
- Class I Equipment (grounded type)
- Mains supply voltage fluctuations are not to exceed $\pm 10\%$ of the nominal supply voltage.
- Pollution Degree II
- Installation (overvoltage) Category II for transient overvoltages
- Maximum Relative Humidity: $< 80\%$ RH, non-condensing
- Operating temperature range of $0\text{ }^{\circ}\text{C}$ to $28\text{ }^{\circ}\text{C}$
- Storage and transportation temperature of $-40\text{ }^{\circ}\text{C}$ to $70\text{ }^{\circ}\text{C}$
- Maximum altitude: 3000 m (9843 ft.)
- This equipment is suitable for continuous operation.

Safety Marking Symbols

This section provides a description of the safety marking symbols that appear on the instrument. These symbols provide information about potentially dangerous situations which can result in death, injury, or damage to the instrument and other components.

	Caution, refer to manual		Earth ground Terminal		Alternating current		Visible and/or invisible laser radiation
	Caution, risk of electric shock		Protective Conductor Terminal		Caution, hot surface		Frame or chassis Terminal
	On: In position of a bistable push control. The slash (I) only denotes that mains are on.				Off: Out position of a bistable push control. The circle (O) only denotes that mains are off.		
or (I)				or (O)			

WARRANTY

ILX LIGHTWAVE CORPORATION warrants this instrument to be free from defects in material and workmanship for a period of one year from date of shipment. During the warranty period, ILX will repair or replace the unit, at our option, without charge.

Limitations

This warranty does not apply to fuses, lamps, defects caused by abuse, modifications, or to use of the product for which it was not intended.

This warranty is in lieu of all other warranties, expressed or implied, including any implied warranty of merchantability or fitness for any particular purpose. ILX Lightwave Corporation shall not be liable for any incidental, special, or consequential damages.

If a problem occurs, please contact ILX Lightwave Corporation with the instrument's serial number, and thoroughly describe the nature of the problem.

Claims for Shipping Damage

When you receive the system, inspect it immediately for any damage or shortages on the packing list. If the system is damaged, file a claim with the carrier. The factory will supply you with a quotation for estimated costs of repair. You must negotiate and settle with the carrier for the amount of damage.

Comments, Suggestions, and Problems

To ensure that you get the most out of your ILX Lightwave product, we ask that you direct any product operation or service related questions or comments to ILX Lightwave Customer Support. You may contact us in whatever way is most convenient:

Phone (800) 459-9459 or (406) 586-1244

Fax (406) 586-9405

On the web at: ilx.custhelp.com

Or mail to:

ILX Lightwave Corporation
P. O. Box 6310
Bozeman, Montana, U.S.A 59771
www.ilxlightwave.com

When you contact us, please have the following information:

Model Number: _____

Serial Number: _____

End-user Name: _____

Company: _____

Phone: _____

Fax: _____

Description of what is connected to the ILX Lightwave instrument:

Description of the problem:

If ILX Lightwave determines that a return to the factory is necessary, you will be issued a Return Authorization (RA) number. Please mark this number on the outside of the shipping box. You or your shipping service are responsible for any shipping damage when returning the instrument to ILX Lightwave; ILX recommends you insure the shipment. Be sure to use enough packing material to prevent shipping damage.

We look forward to serving you even better in the future!

INTRODUCTION



This manual describes the LDM-4405 Laser Diode Mount and explains its operation. Information is also provided to assist in customizing this mount to satisfy specific laser mounting needs. This chapter provides an overview of the LDM-4405 Laser Diode Mount, and contains general information and specifications.

Product Overview

The LDM-4405 is a temperature controlled laser diode mount which allows easy fixturing for many of today's popular TO-Can laser diodes. It allows for precise temperature control of the laser package. The mount provides an innovative laser clamp which allows quick mounting of either 5.6 mm or 9 mm TO-Can lasers. The mount contains both metric (M4) and English (8-32) threaded steel inserts in its base for simple and reliable post mounting.

The LDM-4405 allows direct interfacing to most of ILX's current sources and temperature controllers through standard ILX cables. This gives you the flexibility to select the proper current source or temperature controller for your particular application. Additional flexibility is provided by allowing easy reconfiguration of the mount to match the pin outs found in common laser diode packages.

The LDM-4405 consists of a housing with integrated heat sink, combination cover and clamp, temperature controlled laser mounting plate, thermoelectric module, and PCB assembly (see Figure 1.1). The mount includes a banana jack for a wrist strap or grounding wire, as well as a fitting which allows the user to purge the laser chamber with nitrogen. The rear of the mount houses connectors for both current and temperature control cables and two switches for selecting polarity of the laser diode and photo diode pins.

Figure 1.1 illustrates the LDM-4405 with cover/clamp removed, revealing the laser mounting plate and internal PCB. Figure 1.2 shows the rear of the mount, including connectors and switches.

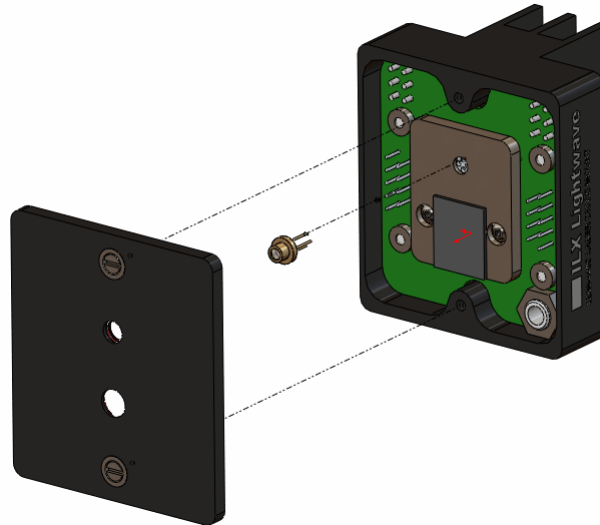

Figure 1.1 Exploded View of the LDM-4405

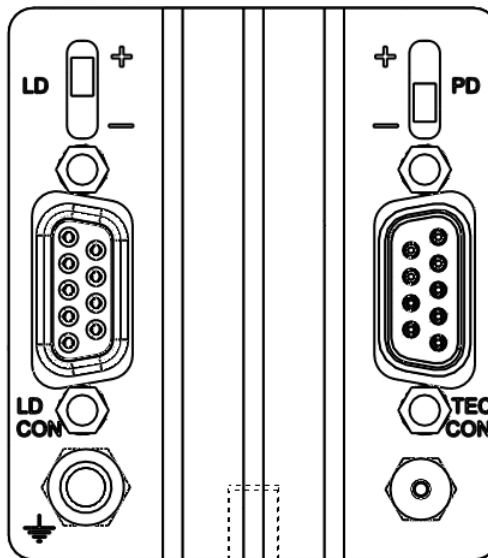

Figure 1.2 Rear View of the LDM-4405

Specifications

Laser Packages	
Styles Supported	5.6 mm and 9 mm TO-can, Type 1
Lead Length	5-20mm
Maximum Laser Current	500 mA
Input Connectors	
Current Source	9-pin D-Sub, female
Temperature Controller	9-pin D-Sub, male
Nitrogen Purge	Brass barbed fitting for 1/16" ID tubing
Ground	Banana jack, female
Temperature Control	
Range ¹	10-85°C
Sensor Type	Calibrated 10kΩ thermistor
TE Module Ratings	
I_{max}	3.9A
V_{max}	3.7V
General	
Size (HxWxD) [in(mm)]	2.3 (57.2) x 2.0 (50.8) x 1.6 (40.6)
Weight	0.30 lb (136g)
Regulatory Compliance	RoHS

1. Minimum achievable temperature depends on laser thermal power. For more information, refer to ILX Technical Note "Temperature Control Range of the LDM-4405".

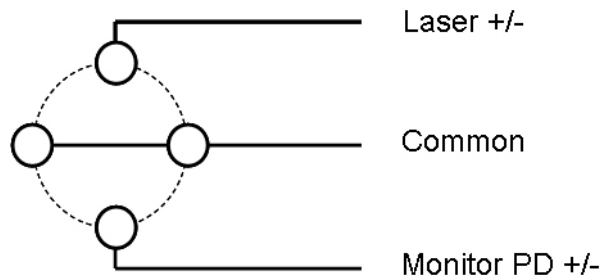

Figure 1.3 Socket Connection Type I

Our goal is to make the best laser diode instrumentation available anywhere. To achieve this, we need your ideas and comments on ways we can improve our products. We invite you to contact us at any time with your suggestions.



This chapter describes the electrical connection and mounting of laser diodes. Configuration options for the LDM-4405 for different device pin outs are also discussed.

Mount Configuration

The LDM-4405 mount is designed for Type 1 TO-can laser diodes containing a laser diode pin, a photodiode pin, and a center common pin. Figure 2.1 shows the pin arrangement on the mount. The laser diode pin can be configured to be either anode or cathode. Likewise, the photo diode pin can be configured to be either anode or cathode. Refer to the datasheet for your laser to determine the polarity of the laser diode and photo diode pins. The rear of the mount contains two switches, one for selecting laser diode polarity and the other for photo diode polarity. Each switch is labeled LD (laser diode) or PD (photo diode) and has 2 positions: + (anode) and - (cathode). The position of the switch selects the polarity of the pin. Table 2.1 shows the four different pinout combinations and the corresponding switch positions.

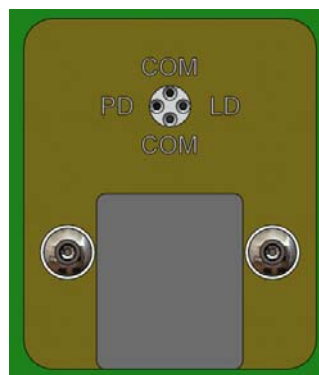

Figure 2.1 Pin Arrangement of the LDM-4405

Table 2.1 Pinout Combinations and Configurations of Laser Diodes - LDM-4405

DESCRIPTION	LASER CONFIGURATION	SWITCH CONFIGURATION
COMMON ANODE		
COMMON CATHODE		
COMMON LD CATHODE AND PD ANODE		
COMMON LD ANODE AND PD CATHODE		

For example, if the laser diode pin on your device is cathode (-) and the photo diode pin is anode (+), you would select the "-" position on the LD switch and the "+" position on the PD switch. This corresponds to the configuration shown in Table 2.1 where the laser diode anode and photo diode are tied together at the common pin.

 **WARNING**

It is imperative that the LDM-4405 is properly configured for your specific laser. If the previous information does not specify clearly the switch settings that are required for your laser, do not operate the laser. Call Customer Service at ILX Lightwave for further information and instructions. When calling, please have all pertinent laser data available for reference.

Laser Diode Mounting

CAUTION

Laser diodes are extremely susceptible to damage caused by electrostatic discharge and surge currents. To avoid early failure or damage to the device, workers and work benches must be grounded at all times when handling or working with laser diodes.

The LDM-4405 mount is equipped with a grounding jack on the rear, which is electrically connected to the mount chassis. We strongly recommend that you electrically ground yourself with a wrist strap so that you are assured of being at the same potential as the mount chassis.

Prior to inserting the laser, connect the current source and temperature controllers to the mount using the appropriate cables (refer to Figures 2.4 and 2.5 for laser and temperature connector pin outs). When the mount electrical connections and laser driver are correctly configured, the laser cathode and anode connections are shorted through an ILX Lightwave current source when the current drive is switched off. This prevents damage to the laser from electrostatic discharge and supports other laser safety features of all ILX Lightwave laser diode drivers.

The LDM-4405 features a 4 pin device test socket that accommodates leads up to 20 mm in length. To install the laser, first remove the cover/clamp by loosening to the two flat head captive screws. Align the laser diode pin of the laser with the receptacle labeled LD and the photo diode pin with the receptacle labeled PD. The common pin should align with one of the two receptacles labeled COM. Gently and evenly push the device pins into the receptacles until the laser package is flush with the laser mounting plate. Figure 2.2 shows correct insertion of a laser diode into the mount.



Figure 2.2 Laser Diode Insertion

The one-piece cover/clamp accommodates both 5.6 mm and 9 mm TO-can devices. The clamp uses an O-ring to apply preload onto the device for good thermal connection to the laser mounting plate. There are two receptacles on the clamp, a smaller diameter one for 5.6mm devices and a larger diameter one for 9mm devices. Rotate the cover/clamp so that the correct receptacle aligns with the device. Secure the cover/clamp using the two flat head captive screws. Tighten until the cover/clamp is flush with the body of the mount. Figure 2.3 displays the mount with a laser and cover/clamp correctly installed. The laser is now ready to test.



Figure 2.3 Mount with Laser and Cover/Clamp Installed

Current Sources and Current Measurements

Operate the LDM-4405 Laser Diode Mount using an appropriate ILX Lightwave current source and temperature controller. Operation with other current sources or temperature controllers is also possible, provided that the correct wiring is observed (refer to Figures 2.4 and 2.5). If an ILX Lightwave current source is used with the system interlock feature, the interlock connections are available at pins 1 and 2 of the current source connector (see Figure 2.4). With the ILX Lightwave interlock feature enabled, the interlock pins must be connected before current can flow from the source.

Proper shielding of the current source and temperature controller signals is necessary to ensure proper noise-free performance. This is accomplished by grounding the shield on the interconnect cables to the controller and not to the mount. The CC-505 Temperature Control Cable provides this shielding automatically by connecting the 15 pin housing into the temperature controller. The CC-305S Current Source Cable, being symmetrical, must be oriented correctly to ensure proper grounding of the shield. This is done by connecting the serial-number end of the cable to the current source. The current source will still drive the laser normally with the cable reversed, but the noise performance will be degraded. If noise becomes excessive during testing, check the orientation of your laser cable.

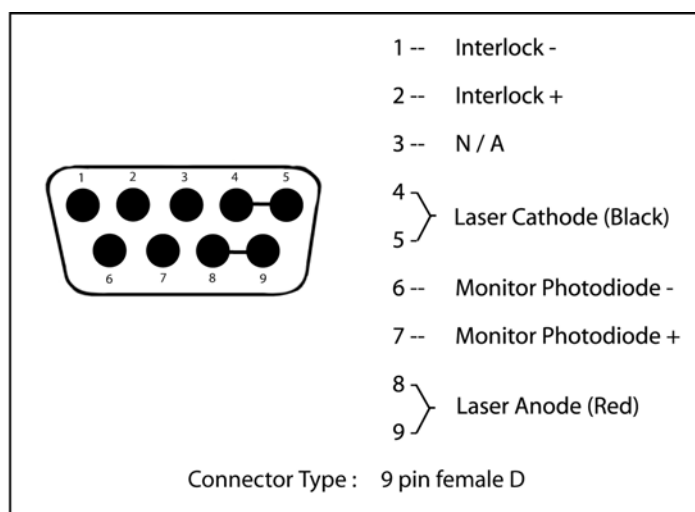

Figure 2.4 LDM-4405 Laser Cable Pinouts

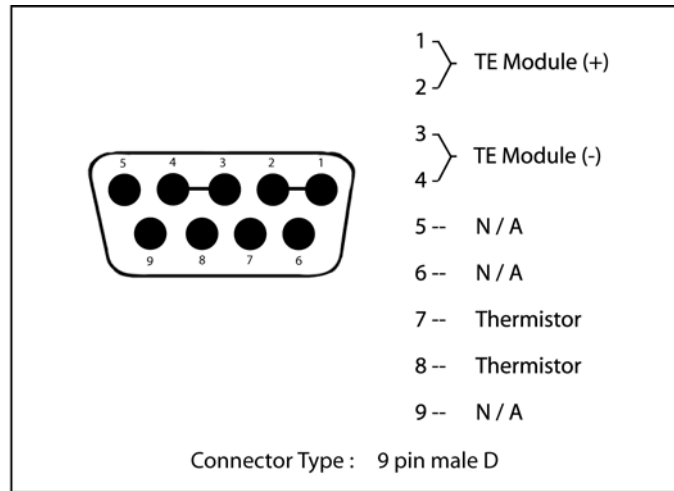

Figure 2.5 LDM-4405 TE Module Cable Pinouts

Do not exceed the specified maximum drive current of the laser. If you are using an ILX Lightwave current source, or any other current source which has an adjustable limit setting, be sure to set the current limit to a safe level for your laser.

If it is necessary to measure the current of your laser during operation, follow these steps:

NEVER connect an ammeter in series with the laser circuit.

Place a known resistance (1 ohm works well) in series with the laser diode circuit. Then, measure the voltage across the resistor. Calculate the current by using Ohm's Law,

$$I = E/R.$$

NEVER turn the voltmeter on or off, or change the voltage measurement range, while current is flowing to the laser. These actions could result in damage to your laser diode.

Most ILX Lightwave current sources measure the output current during laser operation. Therefore, if you are using an ILX Lightwave current source, it is not necessary to measure the laser current as described above.

Temperature Control and Condensation

Thermoelectric Temperature Control

The LDM-4405 contains a single solid-state thermoelectric (TE) module. The TE module is located between the laser plate and the housing heat sink. This Peltier heat pump is capable of heating and cooling the laser diode when supplied with current from an appropriate temperature controller. Feedback from a calibrated thermistor in the laser mounting plate is used to control the laser device's temperature. This temperature control results in the thermal stability required for a precise and consistent light output.

Nitrogen Purge

As the temperature within the LDM-4405 is varied dramatically up and down, the problem of condensation around the laser device and mount becomes a concern. This environmental problem has been addressed by the use of a nitrogen purge. On the rear of the mount is a barbed fitting for 1/16" ID tubing through which any inert gas may be injected. This process ventilates the inner cavity of the LDM-4405, preventing condensation. The inert gas is forced out of the mount across the front facet of the laser through ports in the cover/clamp. The infiltration of airborne particulate matter (such as dust or smoke), which could contaminate the laser, is also prevented.

SAFETY



 **CAUTION**

Laser diodes used with the LDM-4405 Laser Diode Mount may emit infrared radiation which is invisible to the human eye. Extreme care must be taken to prevent the beam from being viewed either directly or through external optics or mirrors. Remove rings, jewelry, and other reflective materials when working with lasers.

Viewing of emissions from the laser may cause eye damage. Use of protective goggles is recommended when operating these lasers.

Use of controls or adjustments or performance of procedures other than those specified herein may result in hazardous radiation exposure.

This product conforms to all applicable DHHS regulations 21 CFR Subchapter J, at the date of manufacture.

