



User's Guide

500 mA Current Source Module
CSM-39050



ILX Lightwave Corporation • P. O. Box 6310 • Bozeman, MT, U.S.A. 59771 • U.S. & Canada: [1-800-459-9459](tel:1-800-459-9459) • International Inquiries: 406-556-2481 • Fax 406-586-9405

ilx.custhelp.com • www.ilxlightwave.com

SAFETY AND WARRANTY INFORMATION



The Safety and Warranty Information section provides details about cautionary symbols used in the manual, safety markings used on the instrument, and information about the Warranty including Customer Service contact information.

Safety Information and the Manual

Throughout this manual, you will see the words *Caution* and *Warning* indicating potentially dangerous or hazardous situations which, if not avoided, could result in death, serious or minor injury, or damage to the product. Specifically:

CAUTION

Caution indicates a potentially hazardous situation which can result in minor or moderate injury or damage to the product or equipment.

WARNING

Warning indicates a potentially dangerous situation which can result in serious injury or death.

WARNING

Visible and/or invisible laser radiation. Avoid direct exposure to the beam.

General Safety Considerations

If any of the following conditions exist, or are even suspected, do not use the instrument until safe operation can be verified by trained service personnel:

- Visible damage
- Severe transport stress
- Prolonged storage under adverse conditions
- Failure to perform intended measurements or functions

If necessary, return the instrument to ILX Lightwave, or authorized local ILX Lightwave distributor, for service or repair to ensure that safety features are maintained (see the contact information on page vi).

All instruments returned to ILX Lightwave are required to have a Return Authorization Number assigned by an official representative of ILX Lightwave Corporation. See Returning an Instrument on page v for more information.

SAFETY SYMBOLS









This section describes the safety symbols and classifications.

Technical specifications including electrical ratings and weight are included within the manual. See the Table of Contents to locate the specifications and other product information. The following classifications are standard across all ILX Lightwave products:

- Indoor use only
- Ordinary Protection: This product is NOT protected against the harmful ingress of moisture.
- Class I Equipment (grounded type)
- Mains supply voltage fluctuations are not to exceed $\pm 10\%$ of the nominal supply voltage.
- Pollution Degree II
- Installation (overvoltage) Category II for transient overvoltages
- Maximum Relative Humidity: $< 80\%$ RH, non-condensing
- Operating temperature range of $0\text{ }^{\circ}\text{C}$ to $40\text{ }^{\circ}\text{C}$
- Storage and transportation temperature of $-40\text{ }^{\circ}\text{C}$ to $70\text{ }^{\circ}\text{C}$
- Maximum altitude: 3000 m (9843 ft)
- This equipment is suitable for continuous operation.

Safety Marking Symbols

This section provides a description of the safety marking symbols that appear on the instrument. These symbols provide information about potentially dangerous situations which can result in death, injury, or damage to the instrument and other components.

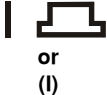
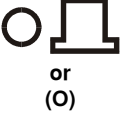
 <p>Caution, refer to manual</p>	 <p>Earth ground Terminal</p>	 <p>Alternating current</p>	 <p>Visible and/or invisible laser radiation</p>
 <p>Caution, risk of electric shock</p>	 <p>Protective Conductor Terminal</p>	 <p>Caution, hot surface</p>	 <p>Frame or chassis Terminal</p>
 <p>On: In position of a bistable push control. The slash (I) only denotes that mains are on.</p>		 <p>Off: Out position of a bistable push control. The circle (O) only denotes that mains are off.</p>	

WARRANTY

ILX LIGHTWAVE CORPORATION warrants this instrument to be free from defects in material and workmanship for a period of one year from date of shipment. During the warranty period, ILX will repair or replace the unit, at our option, without charge.

Limitations

This warranty does not apply to fuses, lamps, defects caused by abuse, modifications, or to use of the product for which it was not intended.

This warranty is in lieu of all other warranties, expressed or implied, including any implied warranty of merchantability or fitness for any particular purpose. ILX Lightwave Corporation shall not be liable for any incidental, special, or consequential damages.

If a problem occurs, please contact ILX Lightwave Corporation with the instrument's serial number, and thoroughly describe the nature of the problem.

Returning an Instrument

If an instrument is to be shipped to ILX Lightwave for repair or service, be sure to:

- 1 Obtain a Return Authorization number (RA) from ILX Customer Service.
- 2 Attach a tag to the instrument identifying the owner and indicating the required service or repair. Include the instrument serial number from the rear panel of the instrument.
- 3 Attach the anti-static protective caps that were shipped with the instrument and place the instrument in a protective anti-static bag.
- 4 Place the instrument in the original packing container with at least 3 inches (7.5 cm) of compressible packaging material. **Shipping damage is not covered by this warranty.**
- 5 Secure the packing box with fiber reinforced strapping tape or metal bands.
- 6 Send the instrument, transportation pre-paid, to ILX Lightwave. Clearly write the return authorization number on the outside of the box and on the shipping paperwork. ILX Lightwave recommends you insure the shipment.

If the original shipping container is not available, place your instrument in a container with at least 3 inches (7.5 cm) of compressible packaging material on all sides.

Repairs are made and the instrument returned transportation pre-paid. Repairs are warranted for the remainder of the original warranty or for 90 days, whichever is greater.

Claims for Shipping Damage

When you receive the instrument, inspect it immediately for any damage or shortages on the packing list. If the instrument is damaged, file a claim with the carrier. The factory will supply you with a quotation for estimated costs of repair. You must negotiate and settle with the carrier for the amount of damage.

Comments, Suggestions, and Problems

To ensure that you get the most out of your ILX Lightwave product, we ask that you direct any product operation or service related questions or comments to ILX Lightwave Customer Support. You may contact us in whatever way is most convenient:

Phone (800) 459-9459 or (406) 586-1244

Fax (406) 586-9405

Email support@ilxlightwave.com

Or mail to:

ILX Lightwave Corporation
P. O. Box 6310
Bozeman, Montana, U.S.A 59771
www.ilxlightwave.com

When you contact us, please have the following information:

Model Number: _____

Serial Number: _____

End-user Name: _____

Company: _____

Phone: _____

Fax: _____

Description or sketch of what
is connected to the ILX
Lightwave instrument:

Description of the problem:

If ILX Lightwave determines that a return to the factory is necessary, you are issued a Return Authorization (RA) number. Please mark this number on the outside of the shipping box.

You or your shipping service are responsible for any shipping damage when returning the instrument to ILX Lightwave; ILX recommends you insure the shipment. If the original shipping container is not available, place your instrument in a container with at least 3 inches (7.5cm) of compressible packaging material on all sides.

We look forward to serving you even better in the future!

CSM-39050
500 mA Current Source Module

Instruction Manual

1.0 Introduction

The CSM-39050 500 mA Current Source is a precision current source module for use in the LDC-3900 Modular Laser Diode Controller. It may be installed in any of the four bays at the rear of the LDC-3900 (and may readily be interchanged with any other LDC-3900 module).

Features of the CSM-39050 include:

- Service-free modularity (calibration information is stored on the CSM-39050)
- Closed-case calibration
- High-stability, low noise design
- Flexible setup with LDC-3900 Save/Recall front panel functions
- Photodiode feedback control mode
- Modulation input

2.0 CSM-39050 Specifications

Current Source¹

Set Point Accuracy:	$\pm 250 \mu\text{A}$
Set Point Resolution:	$10 \mu\text{A}$
Compliance Voltage (fixed):	6.5 V maximum
Temperature Coefficient:	$< 60 \text{ ppm}/^\circ\text{C}$
Stability ² , for 1 hour:	$< 20 \text{ ppm}$
Stability ³ , for 24 hours:	$< 50 \text{ ppm}$
Noise and Ripple ⁴	
High Bandwidth Mode:	$< 5 \mu\text{A rms}$
Low Bandwidth Mode:	$< 3 \mu\text{A rms}$
CW Mode (with 320 cable):	$< 2 \mu\text{A rms}$
Bandwidth	
High Bandwidth Mode:	DC to 175 KHz
Low Bandwidth Mode:	DC to 4 KHz
CW Mode (with 320 cable):	DC to 30 Hz

¹All values relate to a one-hour warm-up period.

²Over any 1-hour period, half-scale output.

³Over any 24-hour period, half-scale output.

⁴Measured from resulting intensity fluctuations of a laser diode, measured optically with a 150kHz bandwidth photodetector. Measurements made with 1 Mhz detector are typically 10% higher. For more information refer to ILX Noise and Transient Test Standards publication.

39050 Laser Current Source Specifications (continued)

Worst Case Transients

Operational ⁵ :	<1 mA
Power-Line induced ⁶ :	<5 mA

Photodiode Feedback

Range:	5 to 5000 μ A
Output Stability ⁷ :	\pm 1 μ A
Accuracy:	\pm 2.5 μ A
Bias Voltage:	0 - 5 V reverse bias (\pm 10%) (adjustable on back panel)

Laser Drive Current Display

Output Current Range:	0.000 to 500.00 mA
Output Current Resolution:	0.01 mA
Output Current Accuracy at 25°C:	\pm 0.25 mA
Photodiode Current Range:	0 - 5,000 μ A
Photodiode Current Resolution:	1 μ A
Photodiode Current Accuracy:	\pm 2.5 μ A
Responsivity Range:	0 - 600.00 μ A/mW
Responsivity Resolution:	0.01 μ A/mW
Optical Power Range:	0 - 500.00 mW
Output Power Resolution:	10 μ W
Type:	5-digit green LED

Current Limit Setting

Range:	0 - 505 mA
Resolution:	1 mA
Accuracy:	\pm 2 mA

Output Connectors

Current Source Output:	9-pin, D-sub
Photodiode Input:	Coax BNC
Analog Modulation Input:	Coax BNC, instrumentation amplifier input

⁵Maximum output current transient resulting from normal operational situations (e.g., power on-off), as well as accidental situations (e.g., power line plug removal). For more information refer to ILX Noise and Transient Test Standards publication.

⁶Maximum output current transient resulting from a 200V power line transient spike.

⁷Maximum monitor photodiode current drift over any 30 minute period. Constant-power mode stability specification assumes zero drift in detector responsivity.

3.0 Installation

This section describes the procedures for installing and removing a CSM-39050 module from the LDC-3900.

NOTE - The LDC-3900 will power-up in a default state upon detecting any change in the LDC-3900 system configuration (such as installing a new module). All parameters and SAVE/RECALL settings will be set to default values, based on the new configuration. Calibration data is stored in the CSM-39050 module itself, and is never lost due to reconfiguration of the LDC-3900.

To install the CSM-39050 module into the LDC-3900, follow these steps:

1. **Turn the LDC-3900 power off.**
2. Place the CSM-39050 module into an open bay on the back of the LDC-3900 and slide the module into place. There are tracks at the top and bottom of the bay which guide the module into place. Push the module into place until the board edge clicks into place with an audible "pop." This indicates that the module is "locked" into place. Screw the Module Locking Screws into the back panel to secure the module. It is then ready to be used in the LDC-3900.
3. Power-up the LDC-3900.
4. After the LDC-3900 has completed its power-up sequence, the (ADJUST) LAS indicator which corresponds to the newly installed CSM-39050 module should be lit in green, indicating that the module has been recognized as a LASER current source in its respective bay.

To remove the CSM-39050 module from the LDC-3900, follow these steps:

1. **Turn the LDC-3900 power off.**
2. Unscrew the Module Locking Screws which secure the module to the LDC-3900 back panel.
3. Grasp the CSM-39050 module by handle which extends from the bottom of the back panel. Gently, but firmly, pull the module out of the LDC-3900.
4. If the CSM-39050 module is replaced in the LDC-3900 before the LDC-3900 is powered up again, the LDC-3900 will retain its memory of all parameter settings and SAVE/RECALL values. However, if the LDC-3900 is powered up and detects a change in its system configuration, all parameters and SAVE/RECALL information will be lost. Calibration data is stored in the CSM-39050 module itself, and is never lost due to reconfiguration of the LDC-3900.

4.0 Operation

This section describes the procedures for connecting and running a laser diode with the CSM-39050 module. Refer to Chapter 2 of the [LDC-3900 Instruction Manual](#) for front panel description and operation.

Refer to Figure 4.1 for the following discussion of connections to the CSM-39050.

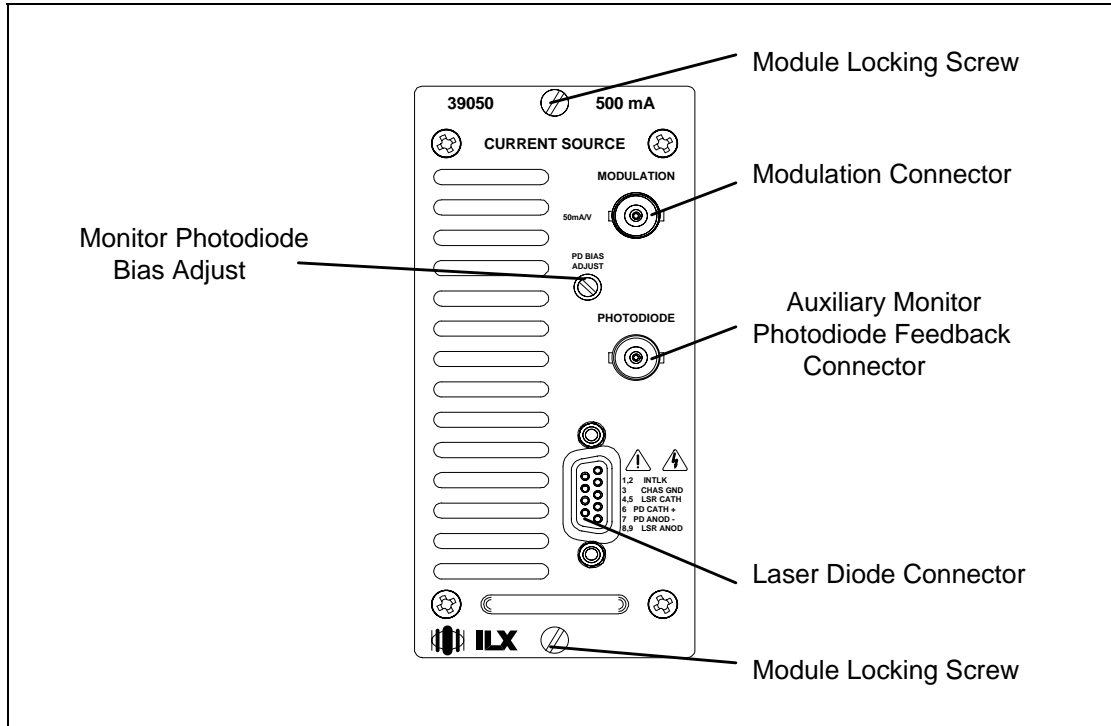

Figure 4.1 CSM-39050 Back Panel

4.1 The LASER Connector

On the back panel of the CSM-39050 you will find a 9-pin D-connector for the LD connections. The pinout diagram for this connector is shown in Figure 4.2.

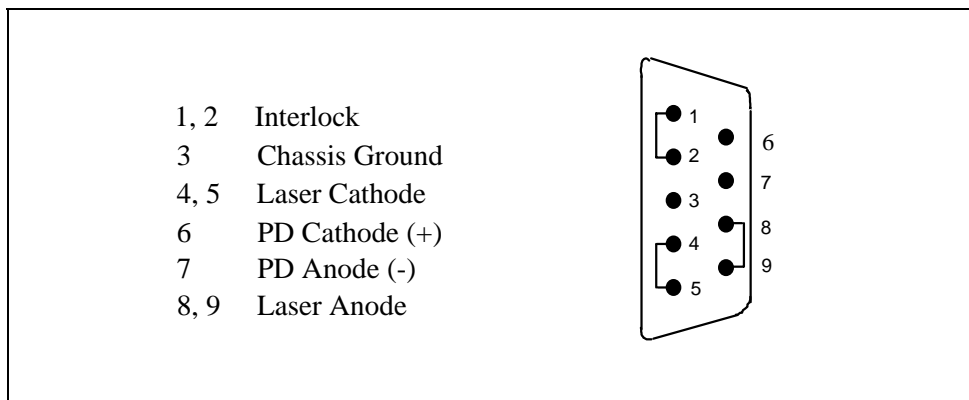

Figure 4.2 Back Panel LD Connector

4.2 Connecting to Your Laser

When connecting laser diodes and other sensitive devices to the CSM-39050, we recommend that the LDC-3900 be powered up and the LASER output be off (LASER MODE ON LED unlit). In this condition, a low impedance shunt is active across the output terminals. When disconnecting devices, it is only necessary to turn the LASER Output off.

4.3 Laser Diode Connections and Shielding

IMPORTANT

Before connecting the laser diode to the LDC-3900 Modular Laser Diode Controller, be sure that the front panel (LASER MODE) ON switch is in the OFF position (ON LED unlit). Before turning on the LASER output, be sure that the current limit has been correctly set.

Figures 4.3 A - D show the possible configurations of connecting laser diodes and photodiodes with the LDC-3900 Modular Laser Diode Controller.

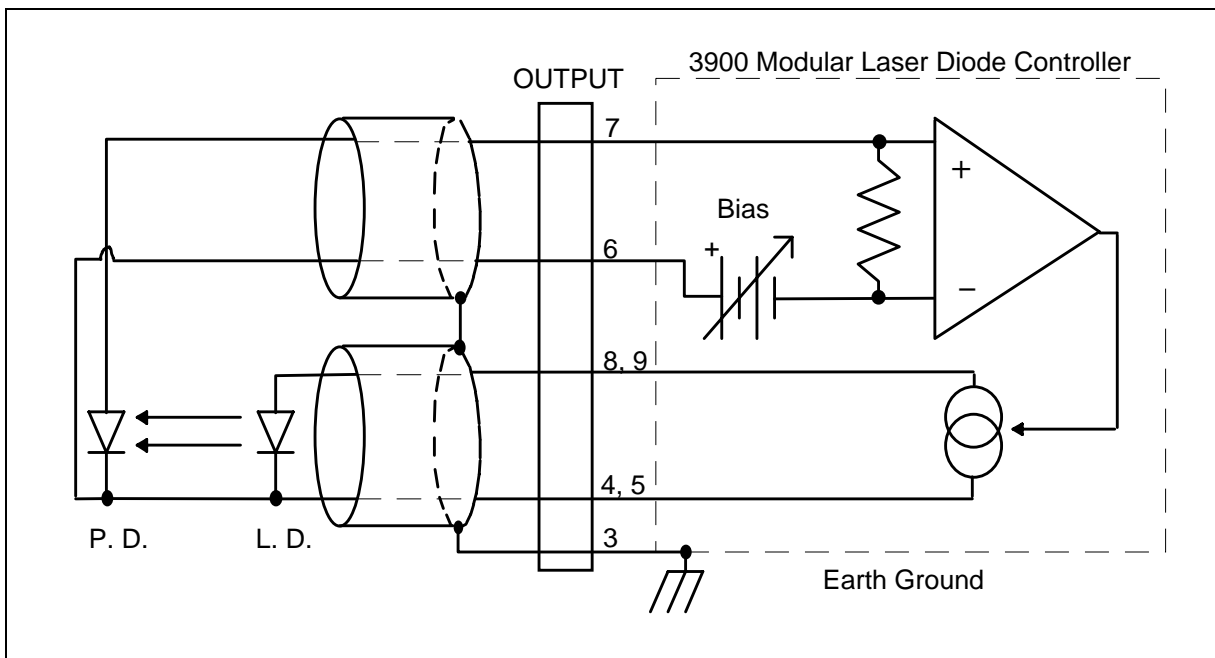

Figure 4.3A Common Laser Cathode - Photodiode Cathode

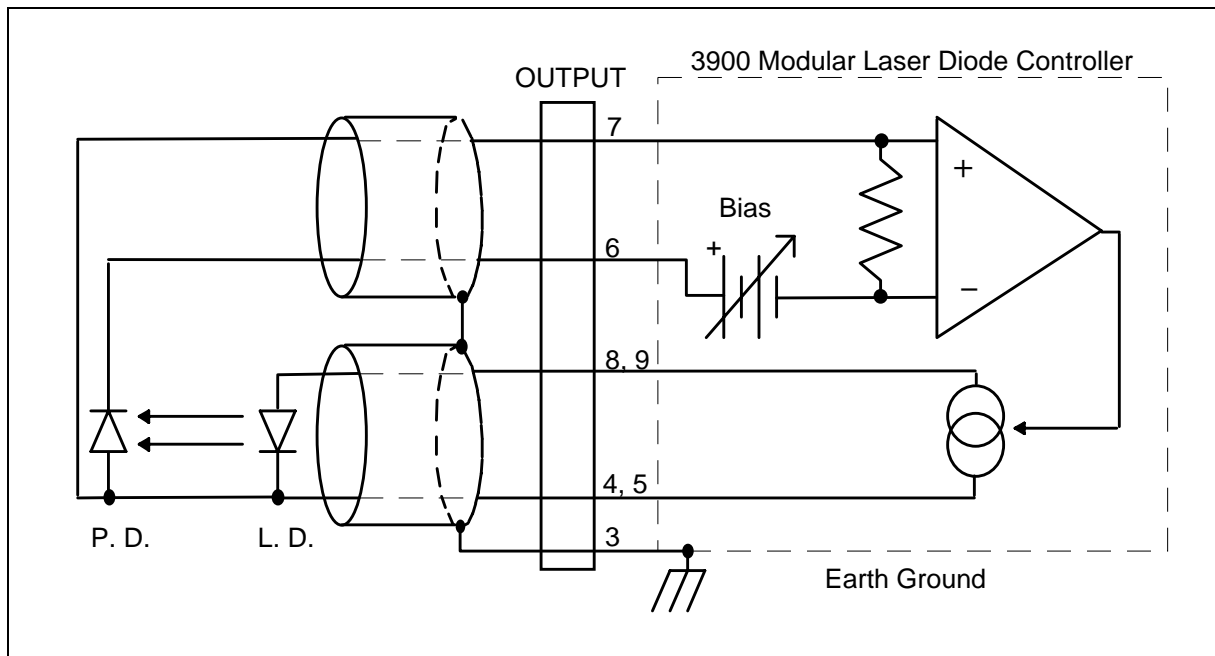

Figure 4.3B Common Laser Cathode - Photodiode Anode

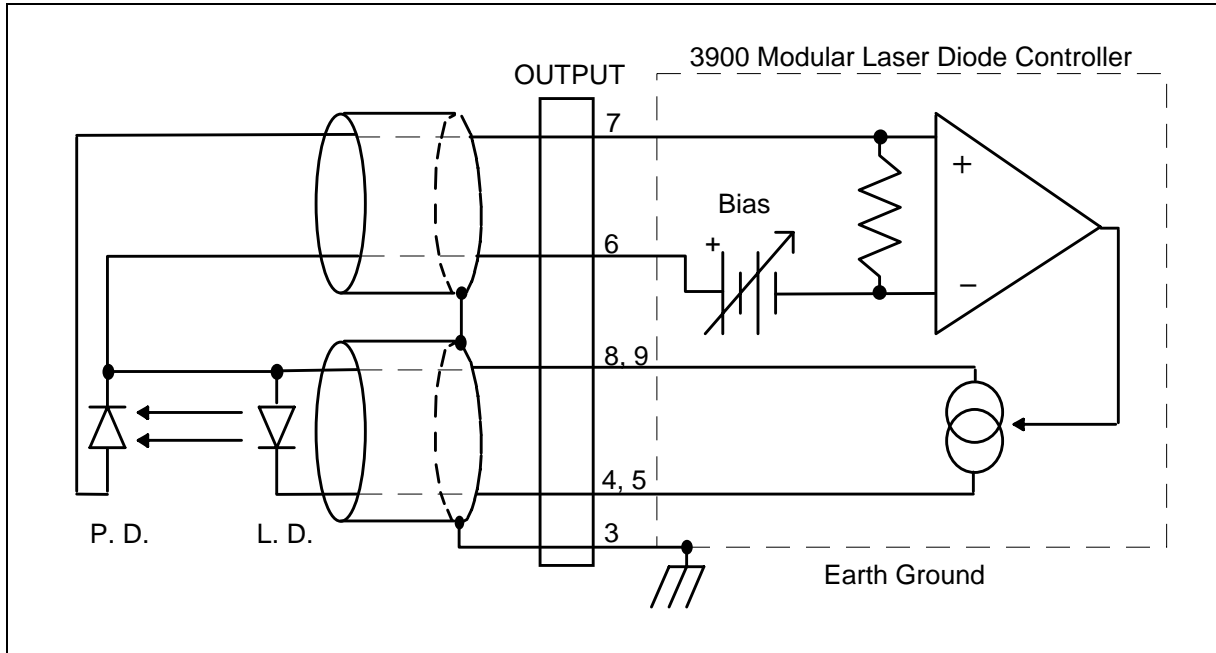

Figure 4.3C Common Laser Anode - Photodiode Cathode

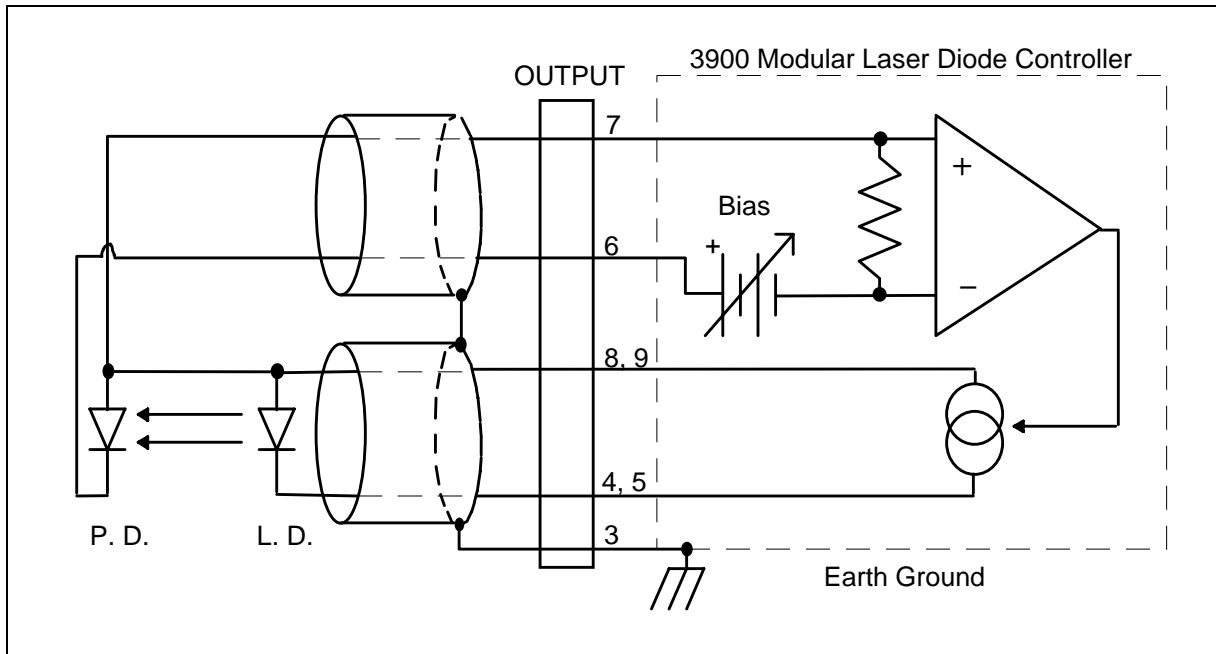

Figure 4.3D Common Laser Anode - Photodiode Anode

IMPORTANT

The cable connections to the laser must be secure enough that they won't open-circuit, should they be jostled or bumped. Should an open circuit occur during laser operation, the LASER output will be turned off (OUTPUT LED unlit) automatically.

Experience indicates that should an open circuit occur during laser operation (while the LASER is ON), the laser may be damaged by a momentary circuit break-and-remake before the final circuit break. Therefore, although the CSM-39050 provides a proprietary debounce protection circuit for the LASER output, secure cabling is important.

It is recommended that the connections to the CSM-39050 output be made using twisted wire pairs with an earth-grounded shield (see Figures 4.3 A - D). The output terminals of the unit are left floating relative to earth ground to suppress AC power-on/power-off transients that may occur through an earth-ground path. If the output circuit is earth-grounded at some point (such as through the laser package and mount), the user must be careful to avoid multiple earth grounds in the circuit. Multiple earth grounds may provide circuit paths that induce spurious currents in the photodiode feedback circuit and output leads.

4.4 Photodiode Feedback Connections

The connector on the back panel of the CSM-39050 contains the current supply output. The photodiode signal is input at the connector at pins 6 and 7 (see Figure 4.2). The CSM-39050 provides an adjustable reverse bias of 0 - 5 V for the photodiode. To set the photodiode bias to 5 volts reverse bias, turn the back panel PHOTODIODE BIAS ADJUST fully clockwise. To set the photodiode bias to 0 volts reverse bias, turn the back panel PHOTODIODE BIAS ADJUST fully counter-clockwise.

The photodiode feedback may also be connected via the PHOTODIODE (BNC) connector, located on the CSM-39050 back panel.

Many laser diode modules contain an internal photodiode that monitors the back-facet emission of the laser. Usually, this photodiode is internally connected to either the laser anode or cathode. Figures 4.2A - 4.2D show the recommended connections and shielding for the various configurations of laser diode modules and photodiode feedback schemes.

The photodiode and laser inputs on the CSM-39050 are electrically isolated from ground and each other. So, if a 4-pin connection is made (no common connections) no additional jumpers are required. Figures 4.2A - 4.2D show the recommended connections and shielding for 3-pin lasers (where the common connection is internal to the device). A 4-pin laser should be connected with the same shielding as shown in Figure 4.2, but the common connection (between the photodiode and the laser) is optional.

4.5 Grounding Considerations

The LASER outputs of the CSM-39050 are isolated from chassis ground allowing either output terminal to be grounded at the user's option. Figure 4.3 shows the proper earth-ground shielding for laser diode/photodiode connections.

4.6 Modulation Connections

The MODULATION connector allows a 50 mV/A modulation signal to be applied to the laser. The modulation port input impedance is 10 k Ω .

5.0 Calibration

The CSM-39050 should be calibrated every 12 months or whenever performance verification indicates that calibration is necessary.

All calibrations can be done with the case closed. The instrument is calibrated by changing the internally stored digital calibration constants.

5.1 Recommended Equipment

Recommended test equipment for calibrating the CSM-39050 is listed in Table 5.1. Equipment other than that shown in the table may be used if the specifications meet or exceed those listed. If your LDC-3900 is equipped with the model 1231 GPIB/IEEE-488.2 interface you may refer to sections 5.4.2, 5.4.4 and 5.4.6 for calibration procedures using the GPIB, if desired.

RECOMMENDED TEST EQUIPMENT

<u>Description</u>	<u>Mfg./Model</u>	<u>Specification</u>
DMM	HP 3457A	0.1 μ A or 0.1 mV resolution
Resistor		15 Ω , 5 W, low TCR, for voltage cal.
<u>I_{PD} Calibration</u>		
Resistors	Metal Film High-power	49 Ω , and 100 Ω , 1%, 1/4 W 5 Ω , 5 W, low TCR
Optical Isolator	TIL117	or equivalent, 6-pin
Connector	D-sub	9-pin male

Table 5.1 Recommended Test Equipment

5.2 Environmental Conditions

Calibrate this instrument under laboratory conditions. We recommend calibration at 23°C \pm 1.0°C. When necessary, however, the CSM-39050 may be calibrated at its intended use temperature if this is within the specified operating temperature range of 0 to 50°C.

5.3 Warm-Up

The LDC-CSM-39050 should be allowed to warm up for at least 1 hour before calibration.

5.4 LASER Controller Calibration Procedures

There are three calibration procedures that need to be made for the CSM-39050. They are calibration of the constant current source (for both bandwidths), calibration of the laser voltage measurement, and calibration of the constant light power (I_{PD}) feedback circuits.

The CSM-39050 implements a two-point calibration for the Laser current source. Two currents are applied to a load, and the resulting measured currents are fed back (by the user) to the CSM-39050. The CSM-39050 calibration program uses the two data points to calculate calibration constants that it will thereafter use to set current.

If you have the optional Model 1231 IEEE-488.2/GPIB interface you may follow the procedure in sections 5.4.2, 5.4.4, and 5.4.6 to calibrate the CSM-39050 remotely.

5.4.1 Local Operation Current Source Calibration

The following procedure is for local (front panel) operation. See Section 5.4.2 for remote calibration of the current source.

- a. Select the CSM-39050 to be calibrated by pressing the appropriate (ADJUST) switch. Set the LASER current limit (LIM I) to full scale, bandwidth as desired, and current set point to 400 mA (80% of full scale). Connect a calibrated DMM to measure the current across the output (pins 5 and 8).
- b. Turn the (LASER ENABLE) ON switch and press the appropriate OUTPUT switch to turn the LASER output on. If the LASER output is not on, the LASER I calibration mode cannot be entered. If the LASER output is on, but the LASER channel is not selected (see Step a), calibration will be performed improperly.
- c. Enter the LASER I calibration mode by pushing the (GPIB) LOCAL and (LASER DISPLAY) I switches at the same time. The LASER display will indicate output current in mA. The LDC-3900 will beep when it is ready to accept a new calibration value.
- d. Press and hold in the (PARAMETER) SET switch and turn the ADJUST knob until the LASER display indicates the same current as measured via the DMM.
- e. Release the (PARAMETER) SET switch to accept the first calibration value. After the (LASER DISPLAY) SET switch is released, the LDC-3900 will beep. It will then apply the second calibration current, approximately one-fourth of the original current.
- f. The LDC-3900 will beep when it is ready to accept the second calibration value. When it does, press and hold in the (PARAMETER) SET switch and turn the ADJUST knob until the LASER display indicates the same current as measured via the DMM.
- g. Release the (PARAMETER) SET switch to accept the second calibration value. After the (PARAMETER) SET switch is released, the LDC-3900 will calculate the calibration constants, store them to nonvolatile memory on the CSM-39050, beep, and return to its former (before calibration) state.
- h. Repeat this procedure with the other bandwidth, if desired.

5.4.2 Remote Operation Current Source Calibration

The following procedure is for remote (GPIB) operation. See Section 5.4.1 for local calibration of the current source.

- a. Select the CSM-39050 to be calibrated by sending the "LAS:CHAN x" command, where x is the channel of the CSM-39050. Set the LASER limit to full scale via the "LAS:LIM:I 500" command, output bandwidth as desired via the "LAS:MODE" command, and current set point to 80% of full scale via the "LAS:LDI 400" command. Connect a calibrated DMM to measure the current across the laser output (pins 5 and 8).
- b. Turn the (LASER ENABLE) ON switch. Enter the "LAS:OUT ON" command to turn the LASER output on. If the LASER output is not on, the LASER I calibration mode cannot be entered.
- c. Enter the LASER I calibration mode by issuing the "LAS:CAL:LDI" command. The LDC-3900 will beep when it is ready to accept the first calibration point.
- d. Input the first actual (measured) LASER output current (as an <nrf value>) via the "LAS:LDI <nrf value>" command.

If this value is to be measured and entered remotely via a GPIB controlled DMM, for example, the measured value of the current should not be entered until the LDC-3900 is ready to receive it.

The LDC-3900 will be ready to receive the current value when, after a "LAS:CAL:LDI?" query is sent, the response from the LDC-3900 is "1".

- e. Once the actual I value is entered via the "LAS:LDI" command, the LDC-3900 will beep and will apply a new current equal to approximately one-fourth (1/4) the previous set current. The LDC-3900 will be ready to receive the second current value when, after a "LAS:CAL:LDI?" query is sent, the response from the LDC-3900 is "1".
- f. Input the second actual (measured) LASER output current (as an <nrf value>) as in Step d.
- g. Once the second actual I value is entered via the "LAS:LDI" command, the LDC-3900 will beep and the new calibration constants will be calculated and stored into non-volatile memory on the CSM-39050. The "OPC?" query may be used (after the "LAS:LDI" value is sent) to determine when the calibration is completed.

The operation complete flag (bit 0 of the Standard Event Status Register) may be used to trigger a service request. This type of interrupt is enabled by setting bit 0 of the Service Request Enable register (via the *ESE command) and bit 5 of the Service Request Enable register (via the *SRE command). Service request (SRQ) handling depends on your GPIB hardware. Refer to your GPIB user's manual for details.

- h. Repeat this procedure with the other range, if desired.

5.4.3 Local Operation I_{PD} Current Calibration

The following procedure is for calibrating the LASER I_{PD} constant current source. This procedure calibrates the feedback circuits for constant I_{PD} and constant P_{PD} modes. When these values are reached and are stable, the user enters the actual value of the current, as measured by an external DMM. The CSM-39050 then automatically calibrates the LASER feedback circuits.

This procedure is for local (front panel) operation. See Section 5.4.4 for remote calibration of the I_{PD} current.

- a. Select the CSM-39050 to be calibrated by pressing the appropriate (ADJUST) switch. With the LASER output off, connect a calibrated ammeter to the PD Anode output of the CSM-39050, and connect the circuit of Figure 5.1 to the LASER and PD outputs.

If a calibrated ammeter (with 0.1 μA resolution) is not available, place a calibrated DMM (with 0.1 mV resolution) to measure the voltage across the resistor, R1, as shown in Figure 6.1. Calculate the current in the following steps by using Ohm's Law:

$$I = E / R$$

-where E is the accurately measured voltage across the resistor, and R is the accurately measured load resistance. (A 4-point probe resistance measurement is recommended.)

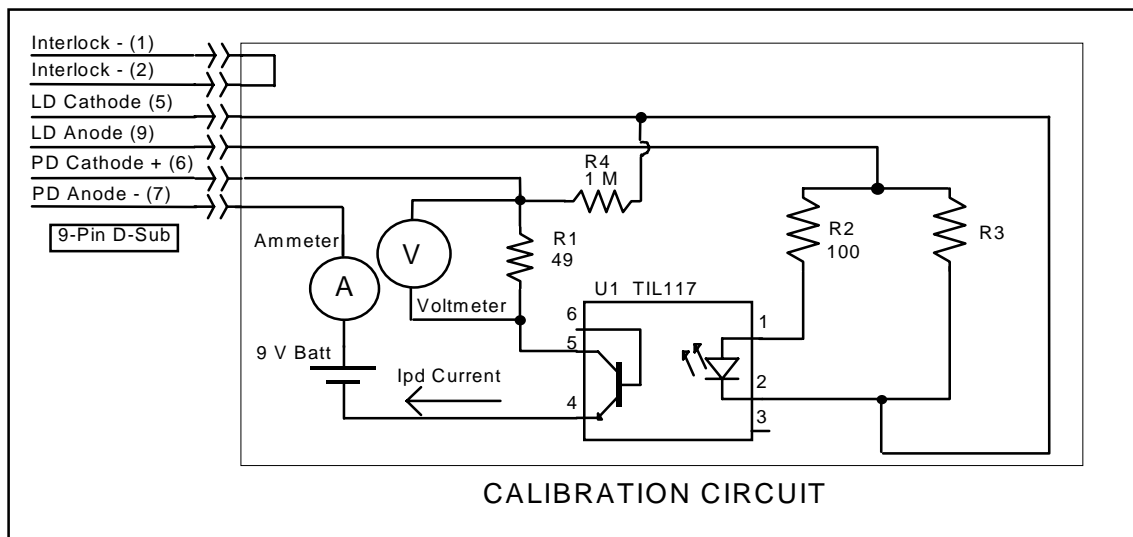

Figure 5.1 I_{PD} Calibration Circuit

- b. Set the LASER current limit (LIM I) to 500 mA. Set the I_{PD} set point to 4000 μA , and set the CAL PD parameter to zero. This puts the CSM-39050 into a constant I_{PD} mode.
- c. Turn the (LASER ENABLE) ON switch and press the appropriate OUTPUT switch to turn the LASER output on. If the LASER output is not on, the LASER I_{PD} calibration mode cannot be entered.
- d. Press the (GPIB) LOCAL and (LASER DISPLAY) I_{PD}/P_{PD} switches at the same time to place the CSM-39050 in its LASER I_{PD} Calibration mode.

After a few seconds the LDC-3900 will beep and the LASER display will show the I_{PD} set point value.

- e. After the value on the LASER display is stable (has not changed by more than one digit for several seconds) the CSM-39050 is ready for the actual I_{PD} value to be entered.

Press and hold in the (PARAMETER) SET switch and turn the ADJUST knob until the LASER display shows the correct value, as shown on the calibrated ammeter (or the calculated I_{PD} value from Step a).

- f. Release the (PARAMETER) SET switch to store the first calibration value into non-volatile memory. It will then expect the second calibration current current, approximately one-fourth of the original current.
- g. The LDC-3900 will beep when it is ready to accept the second calibration value. When it does, press and hold in the (PARAMETER) SET switch and turn the ADJUST knob until the LASER display indicates the same current (as measured directly, or as calculated in Step a, from the measured voltage).
- h. Release the (PARAMETER) SET switch to accept the second calibration point. After the (PARAMETER) SET switch is released, the LDC-3900 will calculate the calibration constants, store them to nonvolatile memory on the CSM-39050, beep, and return to its former (before calibration) state.

5.4.4 Remote Operation I_{PD} Current Calibration

The following procedure is for calibrating the LASER I_{PD} constant current source over GPIB. This procedure calibrates the feedback circuits for constant I_{PD} and constant P_{PD} modes. When these values are reached and are stable, the user enters the actual value of the current, as measured by an external DMM. The CSM-39050 then automatically calibrates the LASER feedback circuits.

This procedure is for remote (GPIB) operation. See Section 5.4.3 for local calibration of the I_{PD} current.

- a. With the LASER output off, connect a calibrated ammeter to the PD Anode output of the CSM-39050, and connect the circuit of Figure 5.1 to the LASER and PD outputs.

If a calibrated ammeter (with 0.1 μ A resolution) is not available, place a calibrated DMM (with 0.1 mV resolution) to measure the voltage across the resistor, R1, as shown in Figure 5.1. Calculate the current in the following steps by using Ohm's Law:

$$I = E / R$$

-where E is the accurately measured voltage across the resistor, and R is the accurately measured load resistance. (A 4-point probe resistance measurement is recommended.)

- b. Select the CSM-39050 to be calibrated by sending the "LAS:CHAN x" command, where x is the channel of the CSM-39050. Set the LASER current limit via the "LAS:LIM:I 500" command. Set the I_{PD} set point to 4000 μ A via the "LAS:MDI 4000" command. Set the CAL PD parameter to zero via the "LAS:CALMD 0" command. This puts the CSM-39050 into a constant I_{PD} (MDI) mode.
- c. Turn the (LASER ENABLE) ON switch. Enter the "LAS:OUT ON" command to turn the LASER output on. If the LASER output is not on, the LASER I_{PD} calibration mode cannot be entered.
- d. Enter the "LAS:CAL:MDI" command to place the CSM-39050 in its LASER I_{PD} Calibration mode.
- e. After a few seconds, the LDC-3900 will be ready for the actual I_{PD} current to be entered via the "LAS:MDI" command. The measured value of the current should not be entered until the LDC-3900 is ready to receive it. The LDC-3900 will beep when it is ready to accept a new calibration value.

The LDC-3900 will be ready to receive the I_{PD} value when, after a "LAS:CAL:MDI?" query is sent, the response from the LDC-3900 is "1".

- f. Once the actual I value is entered via the "LAS:MDI" command, the LDC-3900 will beep and the new calibration value will be stored into non-volatile memory. It will then set the current to approximately one-fourth of the original current and expect the second calibration value to be entered. The LDC-3900 will be ready to receive the second I_{PD} value when, after a "LAS:CAL:MDI?" query is sent, the response from the LDC-3900 is "1".
- g. Input the second actual (measured) I_{PD} current (as an <nrf value>) as in Step e.
- h. Once the second actual monitor diode current value is entered via the "LAS:MDI" command, the LDC-3900 will beep and the new calibration constants will be calculated and stored into non-volatile memory in the CSM-3900. The "OPC?" query may be used (after the "LAS:MDI" value is sent) to determine when the calibration is completed.

The operation complete flag (bit 0 of the Standard Event Status Register) may be used to trigger a service request. This type of interrupt is enabled by setting bit 0 of the Service Request Enable register (via the *ESE command) and bit 5 of the Service Request Enable register (via the *SRE command). Service request (SRQ) handling depends on your GPIB hardware. Refer to your GPIB user's manual for details.

5.4.5 Local Operation Laser Voltage Measurement Calibration

The following procedure is for calibrating the LASER voltage measurement via the front panel. See Section 5.4.5 for remote (GPIB) calibration of the voltage measurement.

- a. With the LASER output off, connect a calibrated voltmeter, in parallel with a 15 Ω , 5 Watt, low temperature coefficient resistor, to the LASER output of the CSM-39050 (pins 5 and 8).
- b. Select the CSM-39050 to be calibrated by pressing the appropriate (ADJUST) switch. Set the LASER current limit (LIM I) to 500 mA. Set the LASER I set point to 400 mA.
- c. Turn the (LASER ENABLE) ON switch and press the appropriate OUTPUT switch to turn the LASER output on. If the LASER output is not on, the LASER voltage calibration mode cannot be entered.
- d. Press the (GPIB) LOCAL and (LASER DISPLAY) V switches at the same time to place the CSM-39050 in its LASER Voltage Calibration mode.
- e. After a few seconds, the LDC-3900 will beep when it is ready to accept a new calibration value. Press and hold in the (PARAMETER) SET switch and turn the ADJUST knob to enter the LASER voltage measurement value which appears on the DMM. Release the (PARAMETER) SET switch to enter the value.

Once the actual voltage value is entered, the LDC-3900 will beep. It will then set the output to approximately one-fourth of the original voltage, and then it will expect the second calibration voltage point to be entered

- f. Input the second actual (measured) LASER voltage (as an <nrf value>) as in Step e.
- g. Once the second actual voltage value is entered, the LDC-3900 will beep and the new calibration constants will be calculated and stored into non-volatile memory on the CSM-39050.

5.4.6 Remote Operation Laser Voltage Measurement Calibration

The following procedure is for calibrating the LASER voltage measurement via GPIB. See Section 5.4.5 for local calibration of the voltage measurement.

- a. With the LASER output off, connect a calibrated voltmeter, in parallel with a 15 Ω , 5 Watt, low temperature coefficient resistor, to the LASER output of the CSM-39050 (pins 5 and 8).
- b. Select the CSM-39050 to be calibrated by sending the appropriate "LAS:CHAN x" command, where x is the channel number of the CSM-39050. Set the LASER current limit via the "LAS:LIM:I 500". Set the I set point via the "LAS:LDI 400" command.
- c. Turn the (LASER ENABLE) ON switch. Enter the "LAS:OUT ON" command to turn the LASER output on. If the LASER output is not on, the LASER voltage calibration mode cannot be entered.
- d. Enter the "LAS:CAL:LDV" command to place the CSM-39050 in its LASER Voltage Calibration mode.
- e. After a few seconds, the LDC-3900 will be ready for the actual laser voltage to be entered via the "LAS:LDV" command. The measured value of the voltage should not be entered until the LDC-3900 is ready to receive it.

The LDC-3900 will be ready to receive the voltage value when, after a "LAS:CAL:LDV?" query is sent, the response from the LDC-3900 is "1".

- f. Once the actual voltage value is entered via the "LAS:LDV" command, the LDC-3900 will beep. It will then expect the second calibration voltage point, approximately one-fourth of the original voltage. The LDC-3900 will be ready to receive the second voltage value when, after a "LAS:CAL:LDV?" query is sent, the response from the LDC-3900 is "1".
- g. Input the second actual (measured) LASER voltage (as an <nrf value>) as in Step e.
- h. Once the second actual voltage value is entered via the "LAS:LDV" command, the LDC-3900 will beep and the new calibration constants will be calculated and stored into non-volatile memory on the CSM-39050.

The operation complete flag (bit 0 of the Standard Event Status Register) may be used to trigger a service request. This type of interrupt is enabled by setting bit 0 of the Service Request Enable register (via the *ESE command) and bit 5 of the Service Request Enable register (via the *SRE command). Service request (SRQ) handling depends on your GPIB hardware. Refer to your GPIB user's manual for details.